

Pipe Size	Hole Size	Weight
54"	70"	21,070#
60"	76"	20,569#

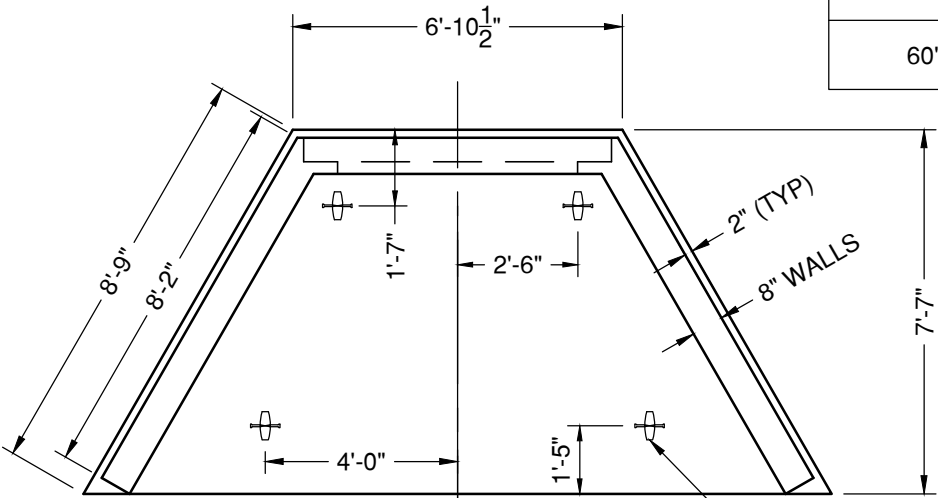

PLAN VIEW

#5 HANDLES
4 PLACES

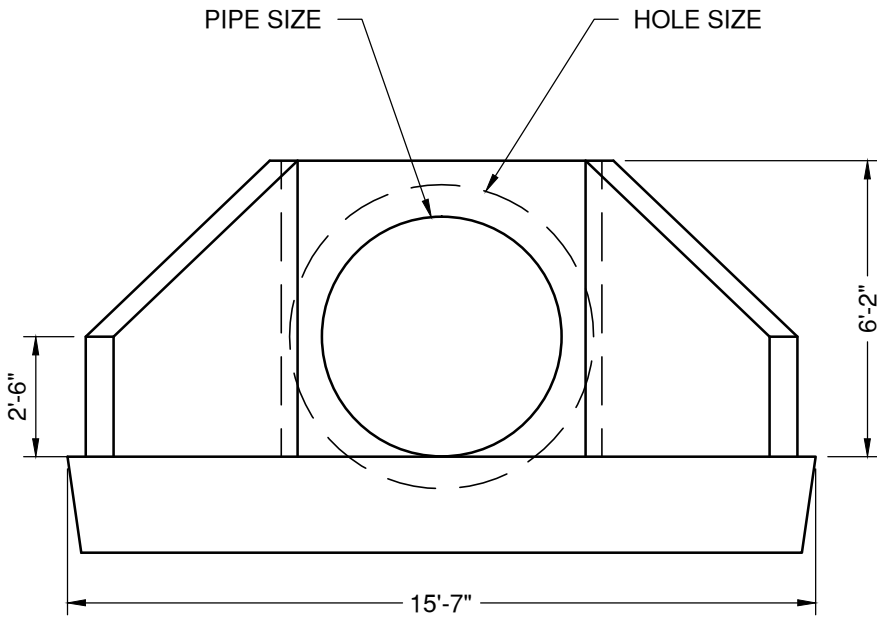

FRONT VIEW

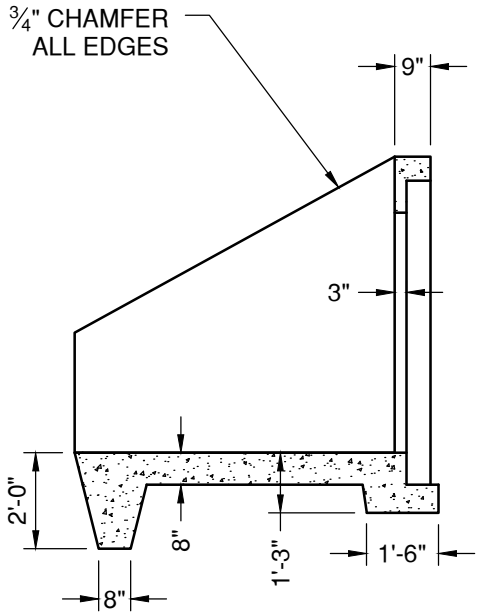

SECTION VIEW



"NPCA" CERTIFIED PLANT
16700 SIMA GRAY RD, HENRYVILLE, IN 47126
Phone: (812) 246-6258 Fax: (812) 294-4862

SPECIFICATIONS

CONCRETE: 4500 PSI @ 28 DAYS
REINFORCEMENT: ASTM A-615, GR 60

WEIGHT: See Chart

**SLOPED & FLARED
HEADWALL
54" - 60" PIPE**

DATE: 10-12-16

DWG #HW-SF-60