

Pipe Size	Hole Size	Weight
19" x 30" (24" EQUIV)	29" x 40"	6,317#

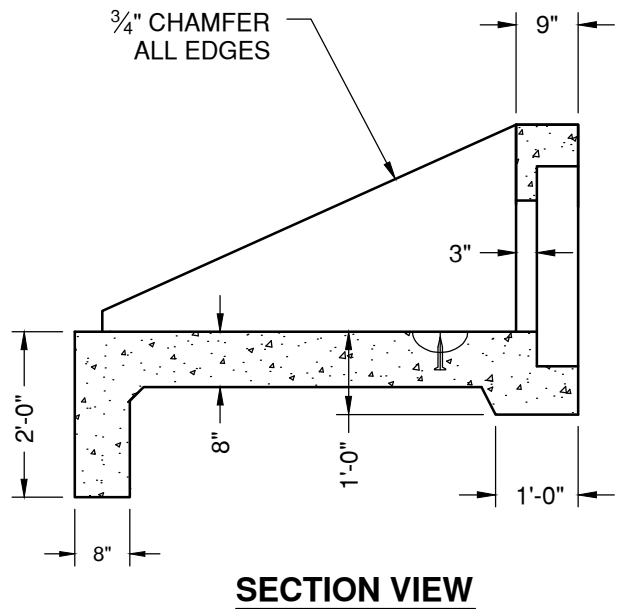
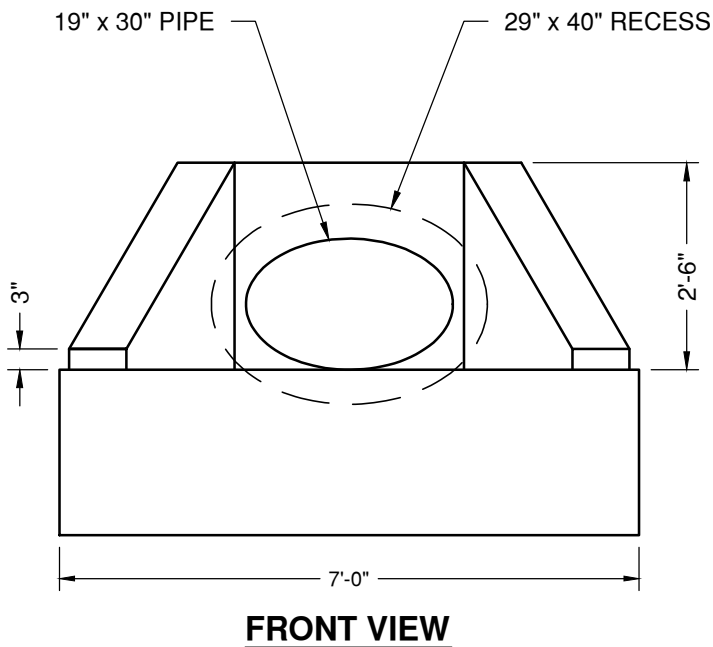
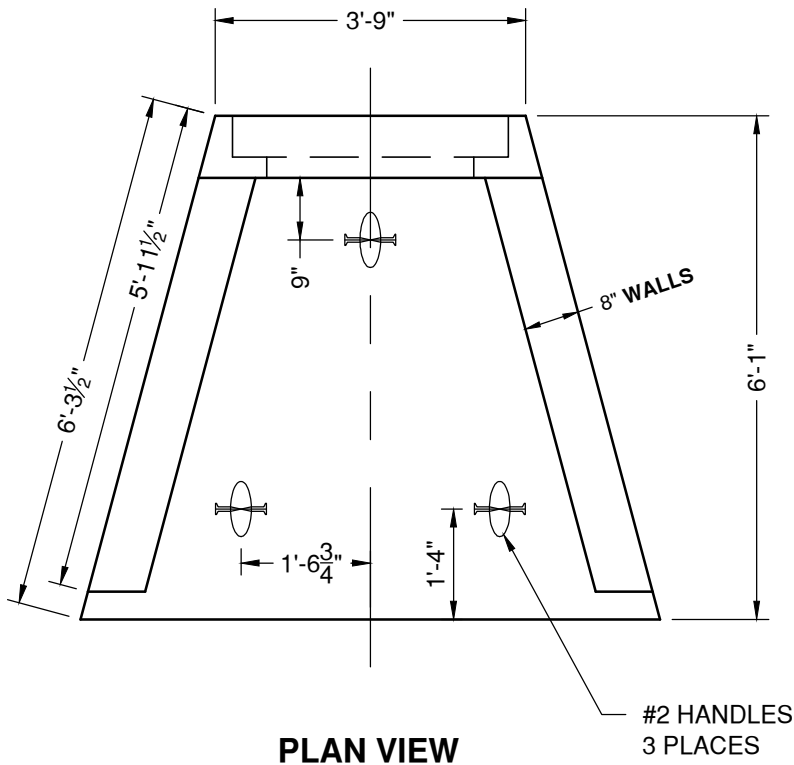

"NPCA" CERTIFIED PLANT
16700 SIMA GRAY RD, HENRYVILLE, IN 47126
Phone: (812) 246-6258 Fax: (812) 294-4862

SPECIFICATIONS

CONCRETE: 4500 PSI @ 28 DAYS
REINFORCEMENT: ASTM A-615, GR 60

WEIGHT: 6,317#

**SLOPED & FLARED
HEADWALL
19" x 30" PIPE**

DATE: 11-17-16

DWG #HW-SF-E24