

Pipe Size	Hole Size	Weight
43" x 68" (54" EQUIV)	59" x 84"	15,250#

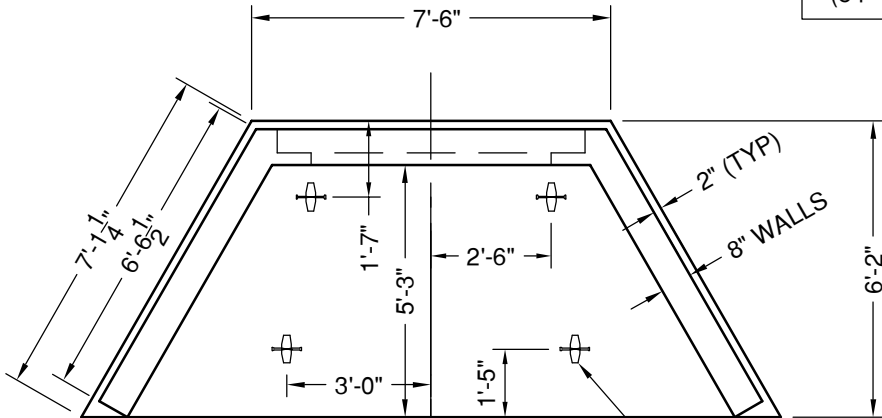

PLAN VIEW

#5 HANDLES
4 PLACES

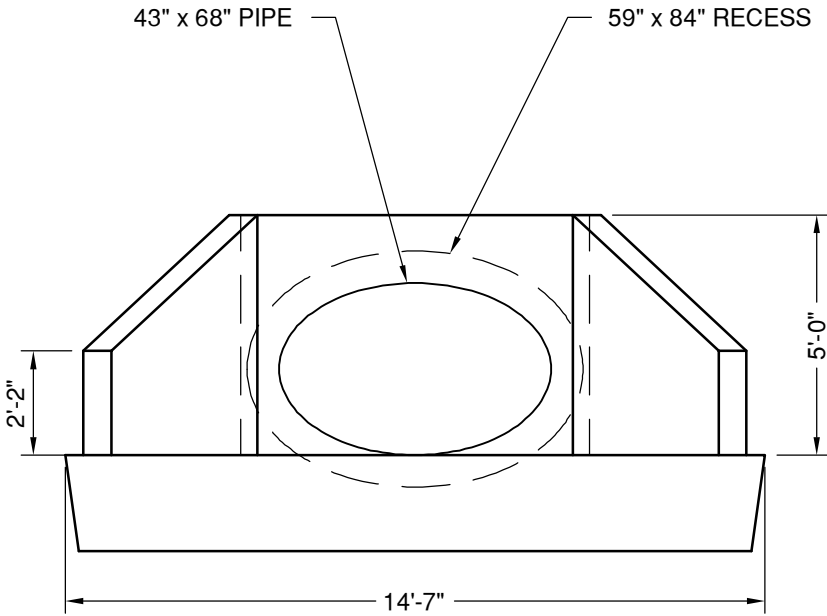

FRONT VIEW

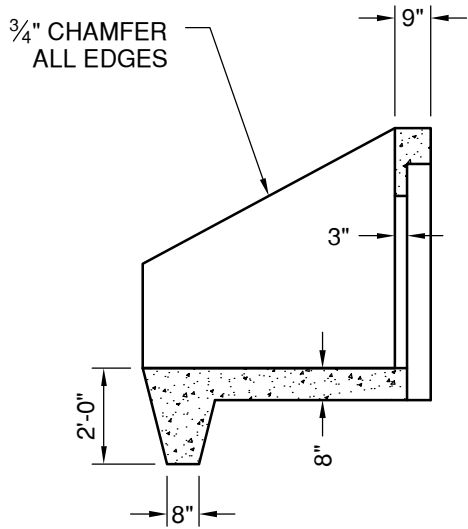

SECTION VIEW



"NPCA" CERTIFIED PLANT
16700 SIMA GRAY RD, HENRYVILLE, IN 47126
Phone: (812) 246-6258 Fax: (812) 294-4862

SPECIFICATIONS

CONCRETE: 4500 PSI @ 28 DAYS
REINFORCEMENT: ASTM A-615, GR 60

WEIGHT: 15,250#

**SLOPED & FLARED
HEADWALL
43" x 68" PIPE**

DATE: 4-11-17

DWG #HW-SF-E54