

Pipe Size	Hole Size	Weight
42"	55"	13,825#
48"	62"	13,380#

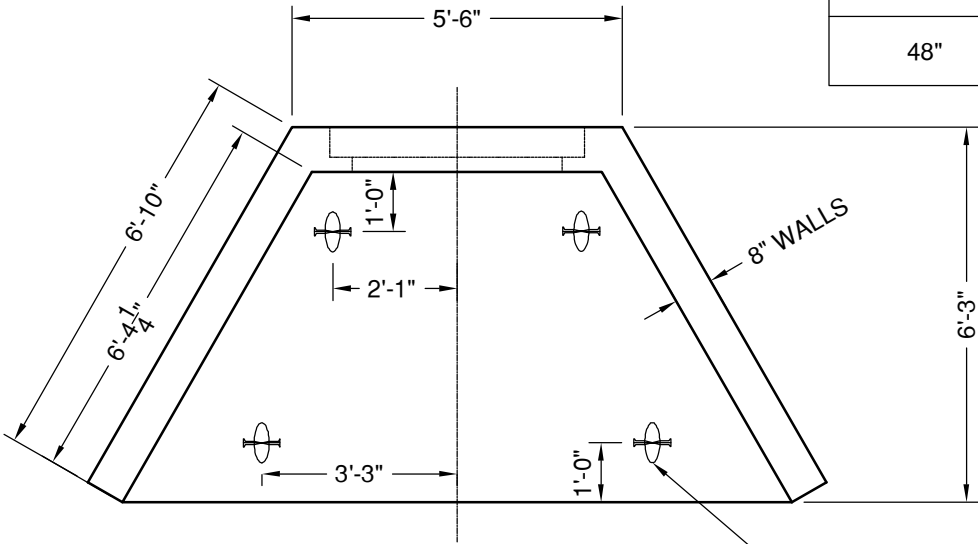

PLAN VIEW

#4 HANDLES
4 PLACES

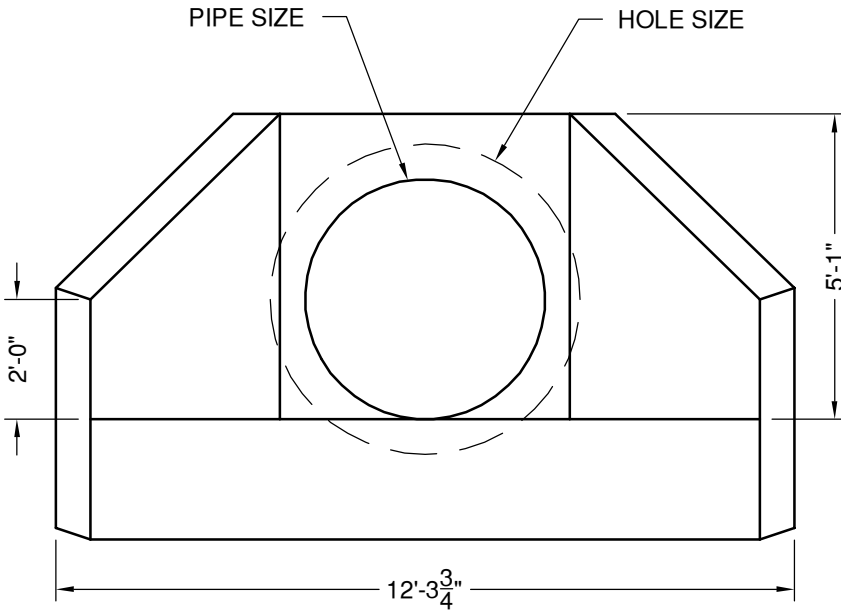

FRONT VIEW

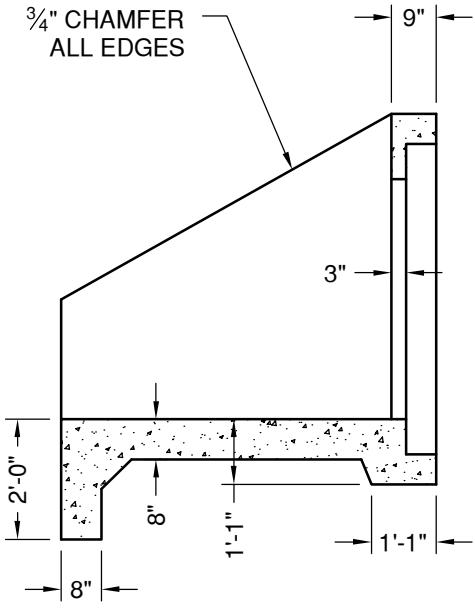

SECTION VIEW



"NPCA" CERTIFIED PLANT
16700 SIMA GRAY RD, HENRYVILLE, IN 47126
Phone: (812) 246-6258 Fax: (812) 294-4862

SPECIFICATIONS

CONCRETE: 4500 PSI @ 28 DAYS
REINFORCEMENT: ASTM A-615, GR 60

WEIGHT: See Chart

**SLOPED & FLARED
HEADWALL
42" - 48" PIPE**

DATE: 2-9-18 DWG #HW-SF-48